

HCXX

Retenció simple de bola amb cos roscat per muntatge en línia.

- Cabal = 10-80 l/min.
- Pressió màxima= 200 bar.
- Material = F-114
- Taratge de la molla a 0,3 bar.

Referències

HC12 - Retenció simple a G1/2"

HC14 - Retenció simple a G1/4"

HC34 - Retenció simple a G3/4"

HC38 - Retenció simple a G3/8"

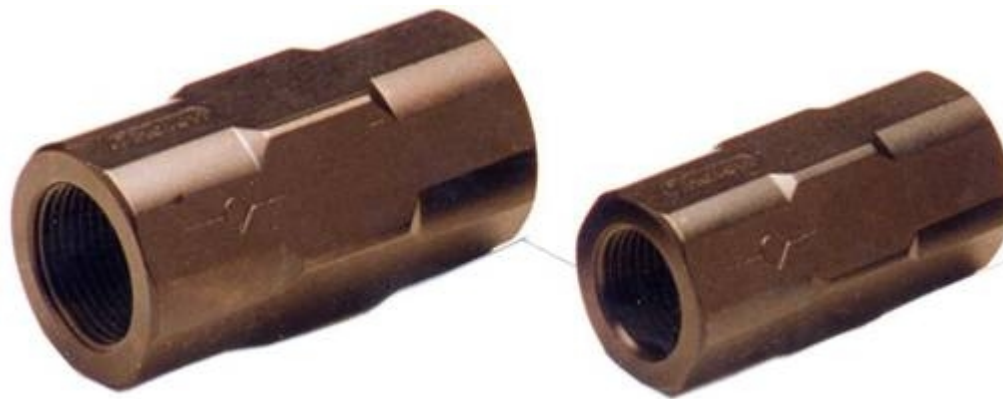

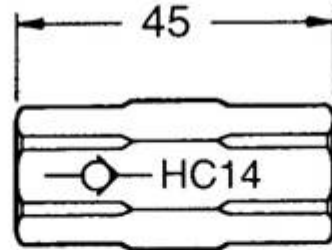
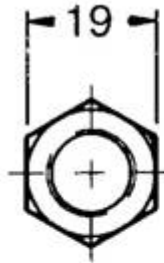

G1/4"

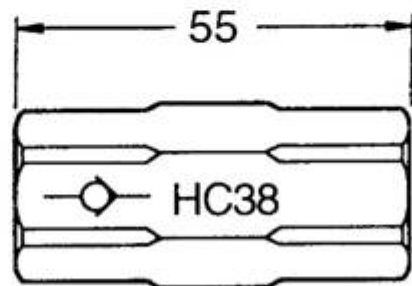
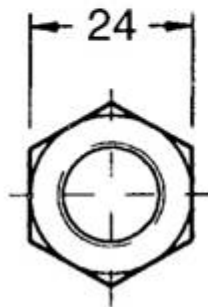

G3/8"

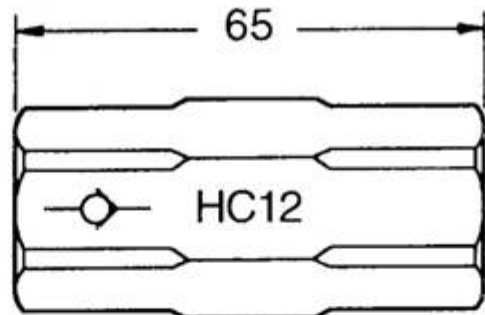
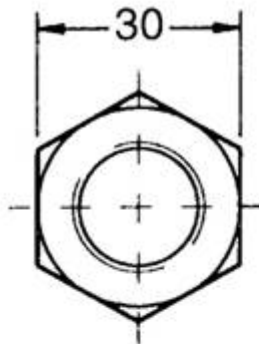

G1/2"

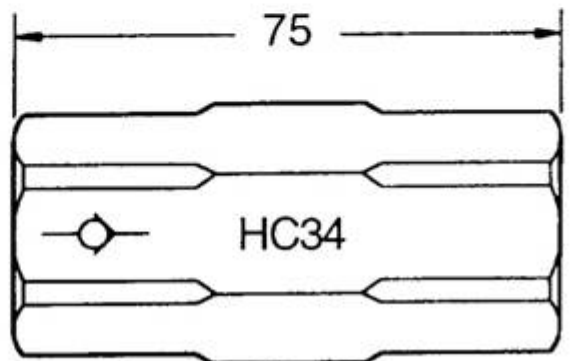
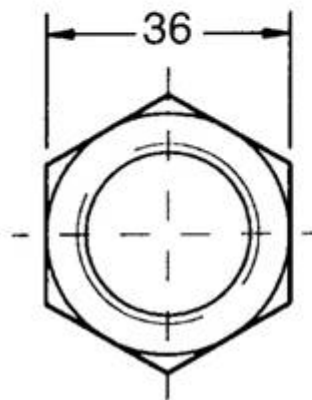

G3/4"

PÉRDIDAS DE CARGA

